

Wooden furniture lock



A-761H-22
Ø16.5mm
A-761V-22
Ø16.5mm



A-761H-30
Ø16.5mm
A-761V-30
Ø16.5mm



A-761H-35
Ø16.5mm
A-761V-35
Ø16.5mm



A-761H-40
Ø16.5mm
A-761V-40
Ø16.5mm

ESPAÑOLETE LOCK



Specifications

- ESPAÑOLETE LOCK
- AVAILABLE IN TWO VERSIONS :
HORIZONTAL & VERTICAL
- FOR 6mm DIAMETER PROFILE ROD
- DIM. D = 15mm FOR SCREW MOUNTING
- ZINC ALLOY DIE CAST

A set includes

- 1 LOCK HOUSING
- 1 CYLINDER CORE
- 2 KEYS
- 1 BEZEL

Dimensions

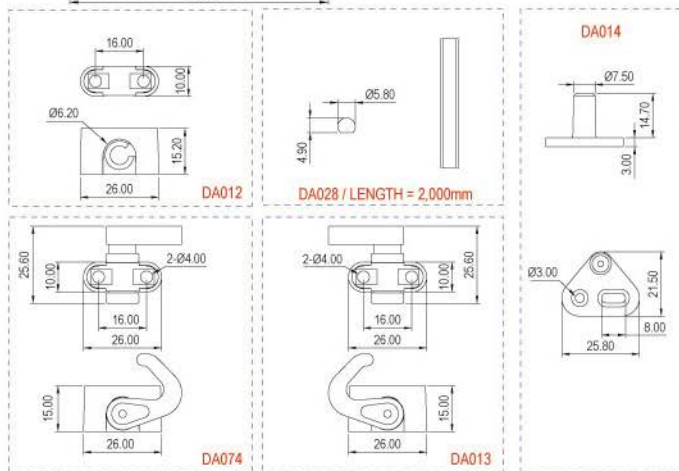
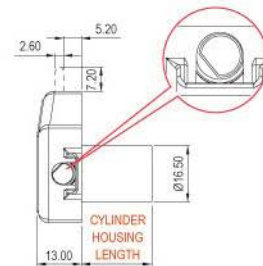
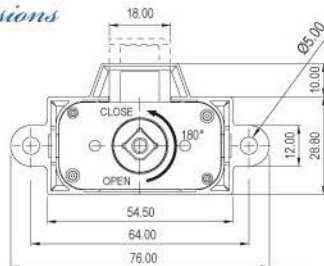

Finished



ESPAÑOLETTE LOCK

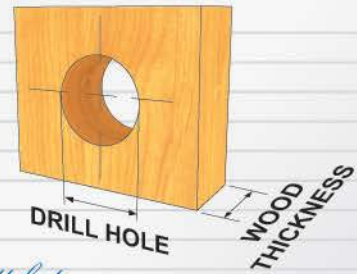

Drill hole

Ø17.5mm FOR 16.5mm HOUSING DIAMETER

Wood Thickness

16-20mm - USE 22mm CYLINDER HOUSING LENGTH

20-28mm - USE 30mm CYLINDER HOUSING LENGTH

28-33mm - USE 35mm CYLINDER HOUSING LENGTH

38-48mm - USE 40mm CYLINDER HOUSING LENGTH

Fixing Details

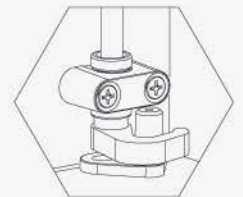
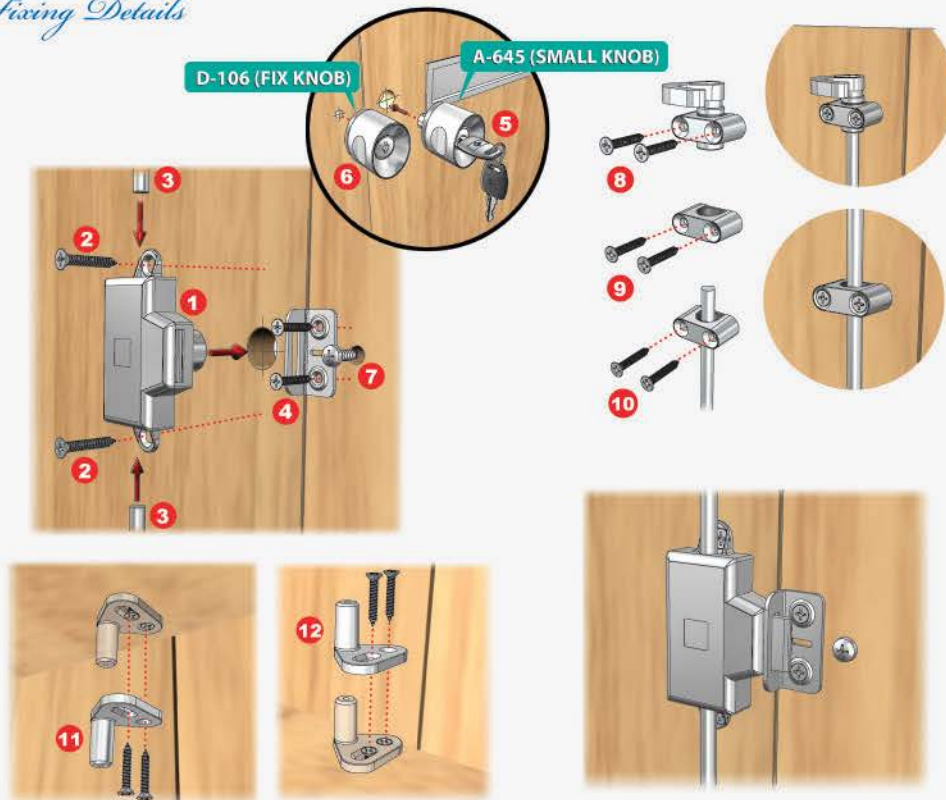

Locked

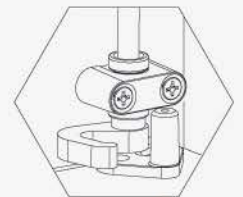

Unlocked